

PS

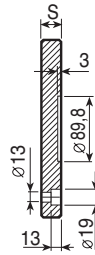

S	22	26	36
		●	

PSX FSX

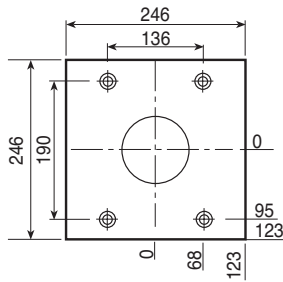
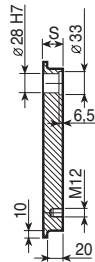
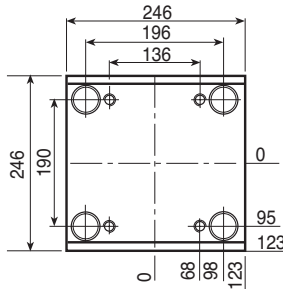

S	26	36	46	56	66	76	96	106	116
	●	●	●	●					

PI-Z FI-Z

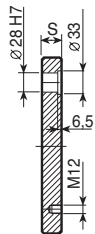
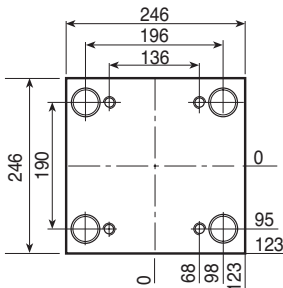

S	26	36	46	56	66	76	96	106	116
	●	●	●	●	●	●	●		

PI FI

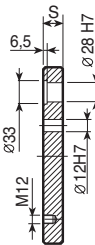
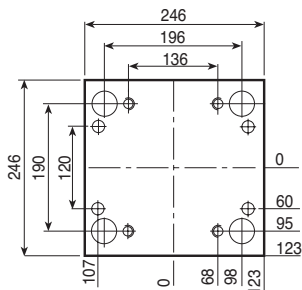

S	26	36	46	56	66	76	96	106	116
	●	●	●	●	●	●	●		

PSXE FSXE

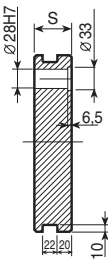
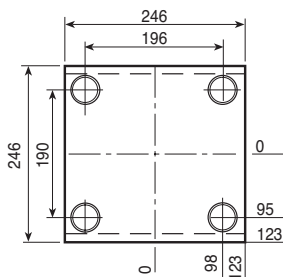

S	26	36	46	56	66	76	96	106	116
			●	●	●	●	●		

PM FM

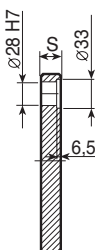
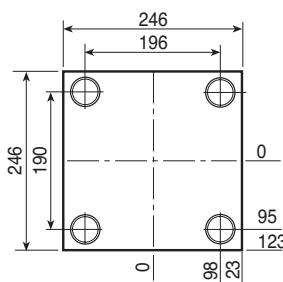

S	26	36	46	56	66	76	96	106	116
	●	●	●	●	●	●	●		

PX FX

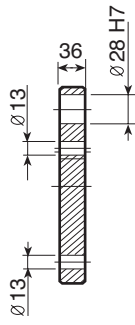
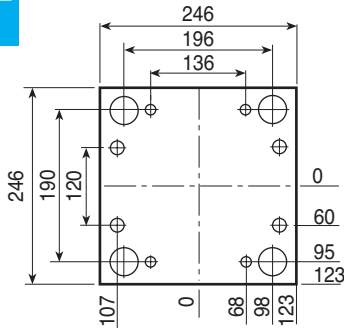

PX-Z FX-Z

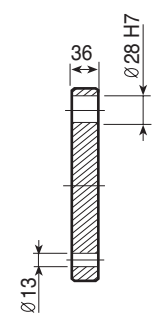
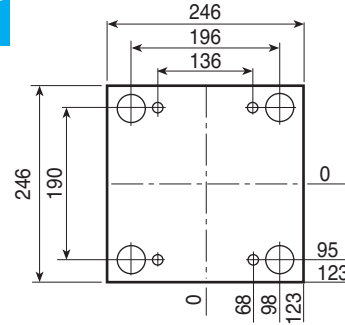

PF

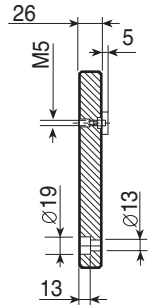
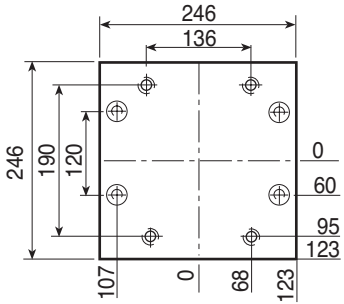

PD

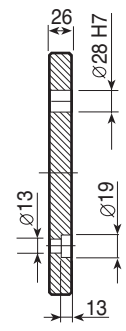
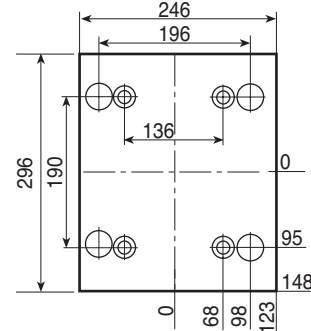

D

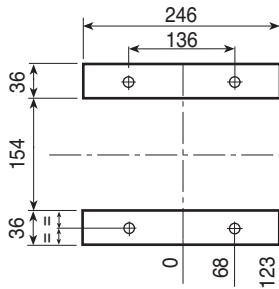

S
57
77
97



D-H

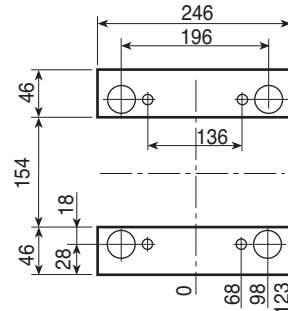

S
57
77
97

TE

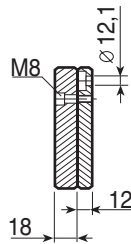
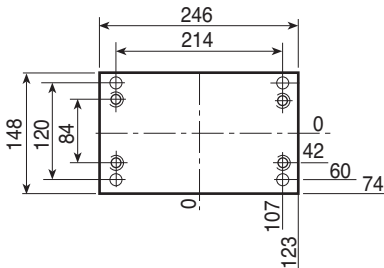

TE-Z

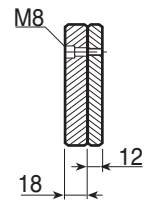
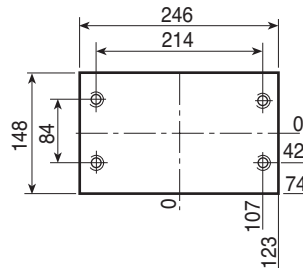

TE-G

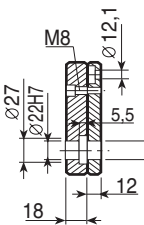
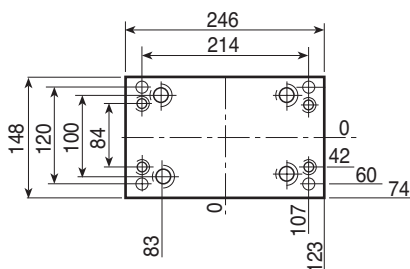

PF-G

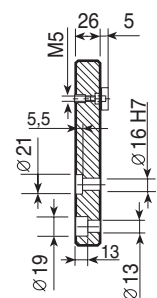
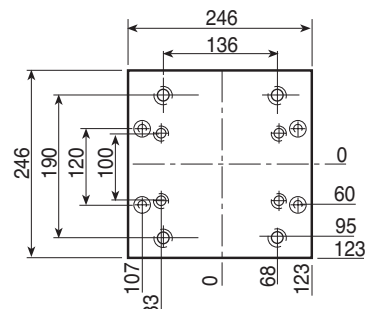

Colonna ECO - 1

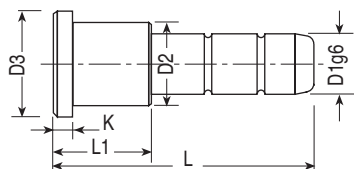

D1	D2	D3	K	X	L1	L = Lunghezza																		
						50	60	70	80	90	100	120	140	160	180	200	220	240	260	280	300	340		
20	28	32	6	10	26	●	●	●	●	●	●													
					36	●	●	●	●	●	●	●												
					46		●	●	●	●	●	●												
					56			●	●	●	●	●	●	●										
					66					●	●	●	●	●	●									
					76						●	●	●	●	●	●								
					86								●	●	●	●	●							
					96									●	●	●	●	●						

Colonna ECO - 1S

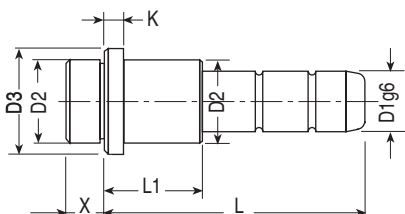

Bussola EBU - 1

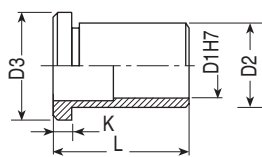

D1	D2	D3	K	L = Lunghezza									
				26	36	46	56	66	76	86	96		
20	28	32	6	●	●	●	●	●	●	●	●		

Colonna ECO - 2

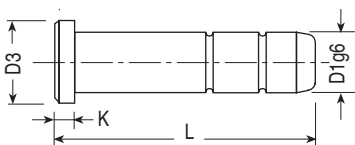

D1	D2	K	L = Lunghezza										
			50	60	70	80	90	100	120	140	160	180	200
16	20	5	●	●	●	●	●	●	●	●	●	●	●

Bussola EBU - 1S

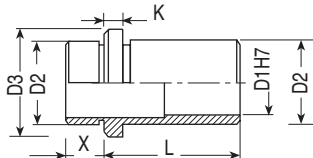

D1	D2	D3	K	X	L = Lunghezza								
					26	36	46	56	66	76	86	96	
20	28	32	6	10	●	●	●	●	●	●	●	●	

Bussola EBU - 3

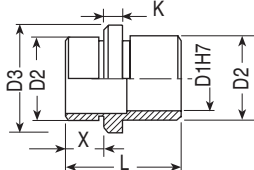

D1	D2	D3	K	X	L
16	22	26	5	11	32
				16	40

Bussola EZP - 1

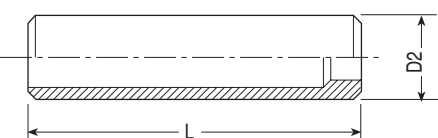

D2	L = Lunghezza									
	30	80	100	120	140					
28	●	●	●	●	●					

Espulsore EES - 2C

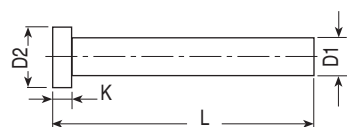

D1	D2	K	L = Lunghezza										
			100	125	160	200	250	315	400	500	630	800	1000
12	18	7	●	●	●	●	●	●	●	●	●	●	●

Vite T.C.C.E.



M	L = Lunghezza																							
	20	25	30	35	40	45	50	55	60	70	80	90	100	110	120	130	140	150	160	180	190	200	220	240
12	●	●	●	●	●	●	●	●	●	●	●	●	●	●	●	●	●	●	●	●	●	●	●	●