

**PS**

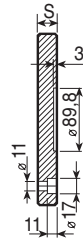

S	22	26	36
	●		

**PSX  
FSX**

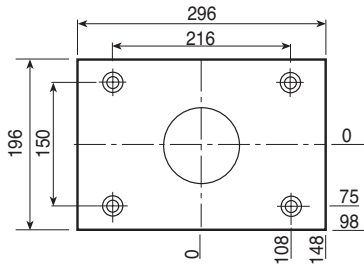
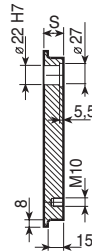
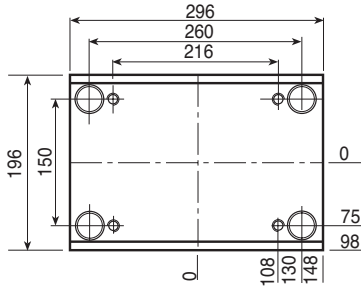

S	26	36	46	56	66	76	96	106	116
	●	●	●	●					

**PI-Z  
FI-Z**

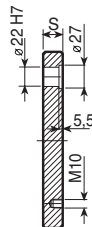
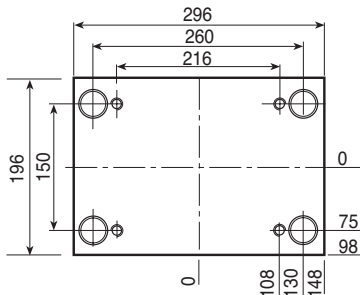

S	26	36	46	56	66	76	96	106	116
	●	●	●	●	●	●	●		

**PI  
FI**

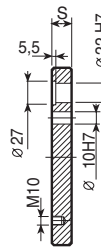
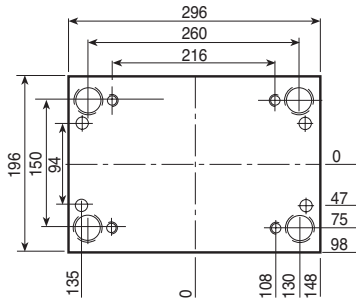

S	26	36	46	56	66	76	96	106	116
	●	●	●	●	●	●	●		

**PSXE  
FSXE**

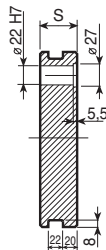
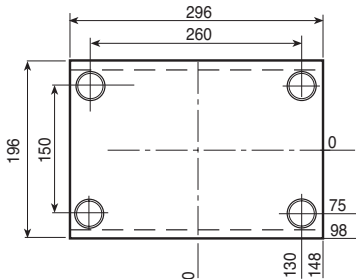

S	26	36	46	56	66	76	96	106	116
			●	●	●	●	●		

**PM  
FM**

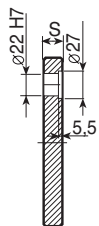
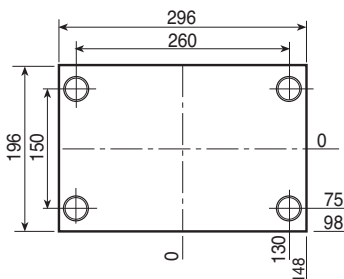

S	22	26	36	46	56	66	76	96	106
	●	●	●	●	●	●	●	●	

## PX FX

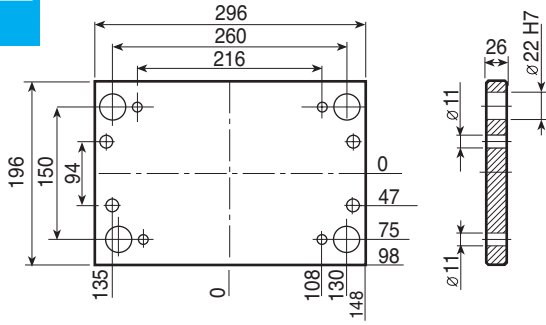

## PX-Z FX-Z

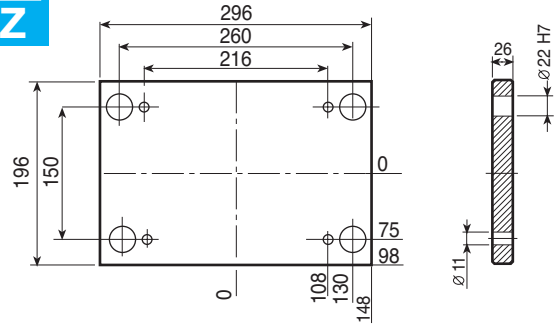

## PF

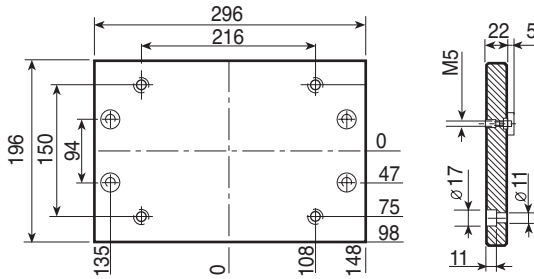

## PD

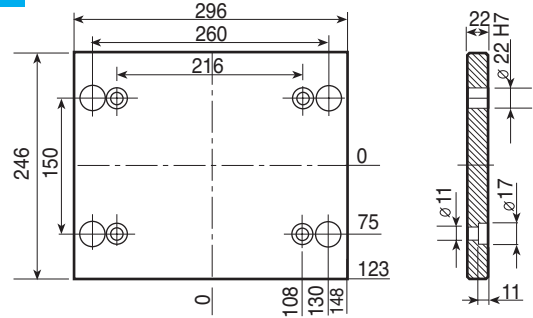

## D

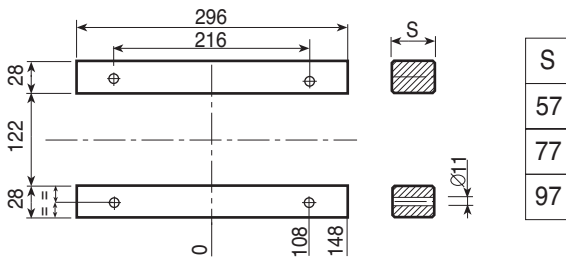

## D-H

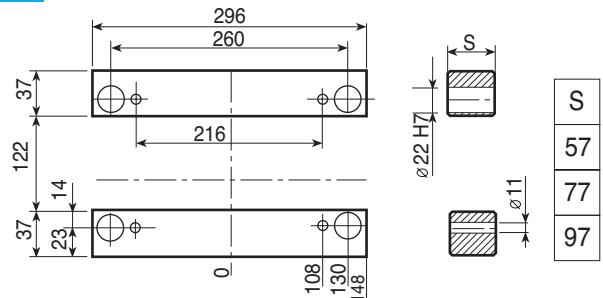

## TE

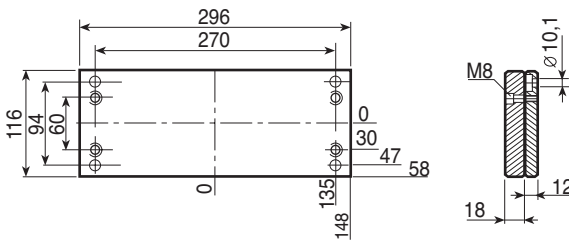

## TE-Z

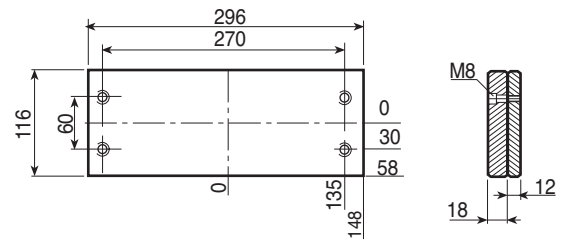

## TE-G

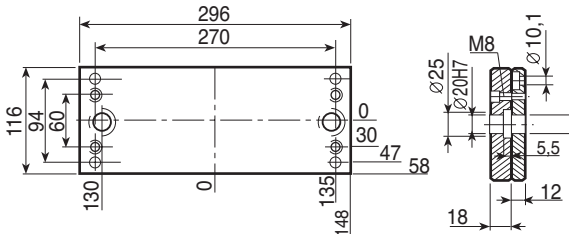

## PF-G

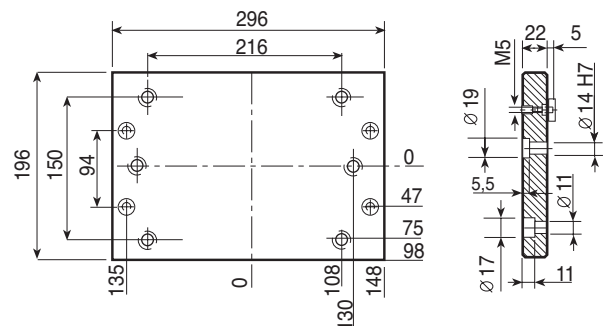

## Colonna ECO - 1

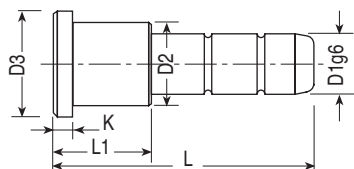

D1	D2	D3	K	X	L1	L = Lunghezza																		
						50	60	70	80	90	100	120	140	160	180	200	220	240	260	280	300	340		
16	22	26	5	10	22	●	●	●	●															
					26	●	●	●	●	●	●													
					36		●	●	●	●	●													
					46		●	●	●	●	●													
					56				●	●	●	●	●	●	●	●	●	●	●	●	●	●	●	●
					66					●	●	●	●	●	●	●	●	●	●	●	●	●	●	●
					76						●	●	●	●	●	●	●	●	●	●	●	●	●	●
					96							●	●	●	●	●	●	●	●	●	●	●	●	●

## Colonna ECO - 1S

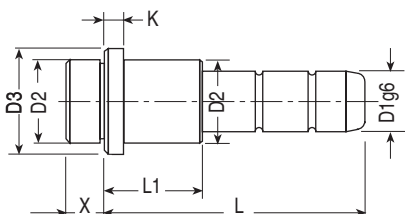

## Bussola EBU - 1

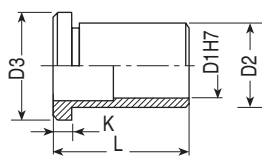

D1	D2	D3	K	L = Lunghezza									
				22	26	36	46	56	66	76	96		
16	22	26	5	●	●	●	●	●	●	●	●		

## Colonna ECO - 2

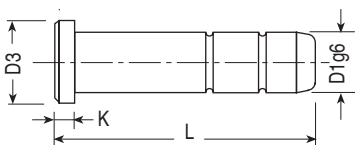

D1	D2	K	L = Lunghezza										
			50	60	70	80	90	100	120	140	160		
14	18	5	●	●	●	●	●	●	●	●	●		

## Bussola EBU - 1S

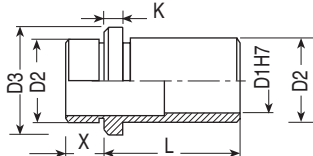

D1	D2	D3	K	X	L = Lunghezza								
					22	26	36	46	56	66	76	96	
16	22	26	5	10	●	●	●	●	●	●	●	●	

## Bussola EBU - 3

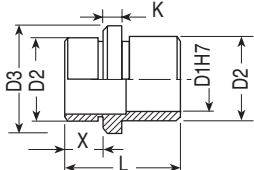

D1	D2	D3	K	X	L
14	20	24	5	11	32
				16	40

## Bussola EZP - 1

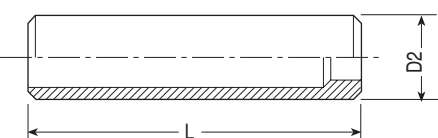

D2	L = Lunghezza									
	30	80	100	120	140					
22	●	●	●	●	●					

## Espulsore EES - 2C

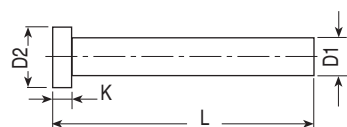

D1	D2	K	L = Lunghezza											
			100	125	160	200	250	315	400	500	630	800	1000	
10	16	5	●	●	●	●	●	●	●	●	●	●	●	●

## Vite T.C.C.E.



M	L = Lunghezza																						
	16	18	20	25	30	35	40	45	50	55	60	70	80	90	100	110	120	130	140	150	160	180	
10	●	●	●	●	●	●	●	●	●	●	●	●	●	●	●	●	●	●	●	●	●	●	●